



INSTYTUT TECHNIKI BUDOWLANEJ
PL 00-611 WARSZAWA
ul. Filtrowa 1
tel.: (+48 22) 825-04-71
(+48 22) 825-76-55
fax: (+48 22) 825-52-86
www.itb.pl



Member of



www.eota.eu

European Technical Assessment

**ETA-19/0551
of 05/10/2020**

General Part

Technical Assessment Body issuing the European Technical Assessment

Instytut Techniki Budowlanej

Trade name of the construction product

PBS

Product family to which the construction product belongs

Concrete screw for use in cracked and uncracked concrete

Manufacturer

PROFIX AG
Kanalstrasse 23
4415 Lausen
Switzerland

Manufacturing plant

Manufacturing Plant no. 6

This European Technical Assessment contains

16 pages including 3 Annexes which form an integral part of this Assessment

This European Technical Assessment is issued in accordance with regulation (EU) No 305/2011, on the basis of

European Assessment Document (EAD) 330232-00-0601 "Mechanical fasteners for use in concrete" and 330011-00-0601 "Adjustable concrete screw"

This version replaces

ETA-19/0551 issued on 05/09/2019

This European Technical Assessment is issued by the Technical Assessment Body in its official language. Translations of this European Technical Assessment in other languages shall fully correspond to the original issued document and should be identified as such.

Communication of this European Technical Assessment, including transmission by electronic means, shall be in full. However, partial reproduction may be made, with the written consent of the issuing Technical Assessment Body. Any partial reproduction has to be identified as such.

Specific Part

1 Technical description of the product

The PBS concrete screw is an anchor made of heat treated and zinc plated (ZP) or zinc flaked (ZF) steel. The anchor is screwed into a predrilled cylindrical drill hole. The special thread of the anchor cuts an internal thread into a concrete member while setting. The anchorage is characterized by mechanical interlock in the special thread.

The description of the product is given in Annex A.

2 Specification of the intended use in accordance with the applicable European Assessment Document (EAD)

The performances given in Section 3 are only valid if the anchors are used in compliance with the specifications and conditions given in Annex B.

The performances given in this European Technical Assessment are based on an assumed working life of the anchor of 50 years. The indications given on the working life cannot be interpreted as a guarantee given by the producer or the Technical Assessment Body, but are to be regarded only as a means for choosing the right products in relation to the expected economically reasonable working life of the works.

3 Performance of the product and references to the methods used for its assessment

3.1 Performance of the product

3.1.1 Mechanical resistance and stability (BWR 1)

Essential characteristic	Performance
Characteristic resistance under static and quasi-static loading	See Annex C1 and C2
Displacements under tension and shear loads	See Annex C2
Characteristic resistance and displacements for seismic performance categories C1 and C2	See Annex C3 and C4

3.1.2 Safety in case of fire (BWR 2)

Essential characteristic	Performance
Reaction to fire	Anchors satisfy requirements for Class A1
Resistance to fire	See Annex C5

3.1.3 Safety and accessibility in use (BWR 4)

For Basic Requirement Safety and accessibility in use are included under Basic Requirement Mechanical resistance and stability (BWR 1).

3.2 Methods used for the assessment

The assessment of the products has been made in accordance with EAD 330232-00-0601 and EAD 330011-00-0601.

4 Assessment and verification of constancy of performance (AVCP) system applied, with reference to its legal base

According to Decision 96/582/EC of the European Commission the system 1 of assessment and verification of constancy of performance applies (see Annex V to Regulation (EU) No 305/2011).

5 Technical details necessary for the implementation of the AVCP system, as provided for in the applicable European Assessment Document (EAD)

Technical details necessary for the implementation of the AVCP system are laid down in the control plan which is deposited at Instytut Techniki Budowlanej.

For type testing the results of the tests performed as part of the assessment for the European Technical Assessment shall be used unless there are changes in the production line or plant. In such cases the necessary type testing has to be agreed between Instytut Techniki Budowlanej and the notified body.

Issued in Warsaw on 05/10/2020 by Instytut Techniki Budowlanej



Anna Panek, MSc
Deputy Director of ITB

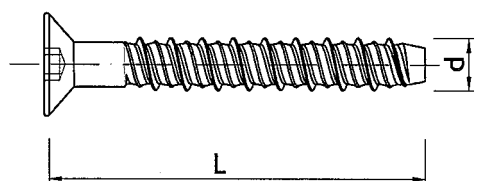

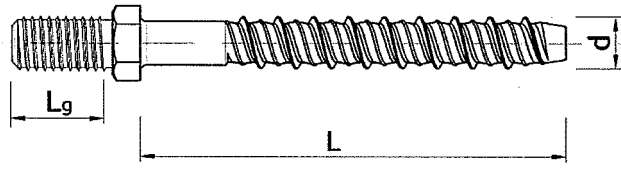

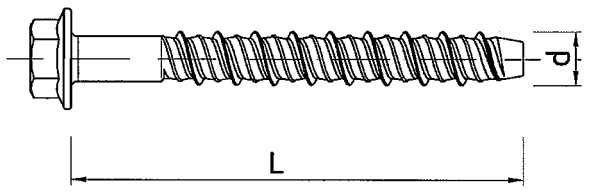

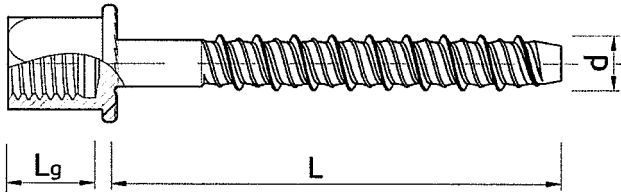
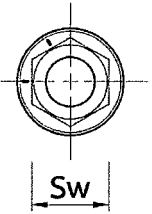
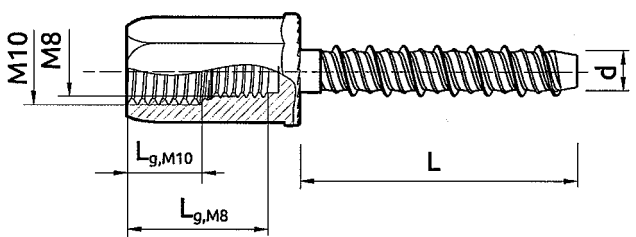
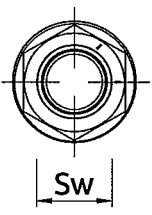
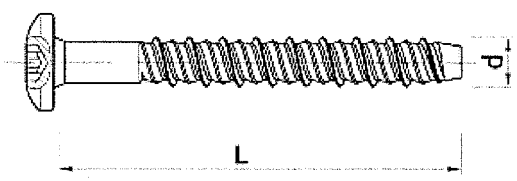

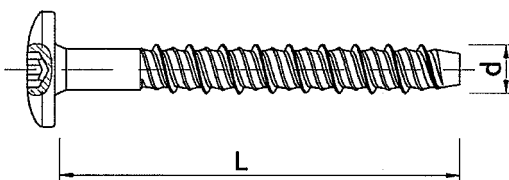

<p>PBS-F</p>		
<p>PBS-ST</p>		
<p>PBS-SS</p>		
<p>PBS-I</p>		
<p>PBS-I</p>		
<p>PBS-P</p>		
<p>PBS-MS</p>		
<p>PBS</p>		<p>Annex A1 of European Technical Assessment ETA-19/0551</p>
<p>Product description Characteristic of the product</p>		

Table A1: Dimensions and materials for PBS-F, PBS-SS, PBS-P and PBS-MS

Anchor size			PBS-05	PBS-06	PBS-08	PBS-10	PBS-12	PBS-14
Thread size	d	mm	6,2	7,5	9,9	12,4	14,9	17,4
Length of anchor	L	mm	45 - 240	45 - 240	60 - 240	60 - 240	75 - 240	80 - 240
Nominal hole diameter	d ₀	mm	5	6	8	10	12	14
Tip chamfer	h _s	mm	2,5	3	4	4,5	6	6
Pitch	h _t	mm	4,2	5	6,7	8,3	10	11,6
Material: carbon steel	f _{uk}	N/mm ²	1300	1250	1200	1050	1000	1020
	f _{yk}	N/mm ²	1150	1100	1050	950	900	800
Coating			Zinc Plated (ZP ≥ 5 μm) or Zinc Flaked (ZF ≥ 5 μm)					

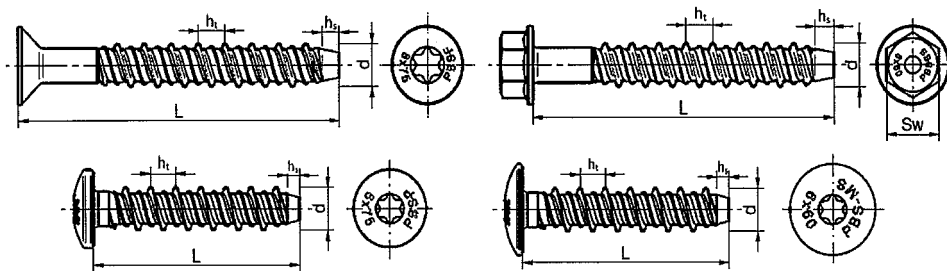
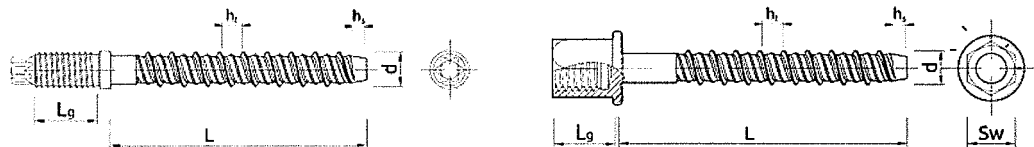


Table A2: Dimensions and materials for PBS-ST and PBS-I

Anchor size			PBS-05	PBS-06	PBS-08	PBS-10
Thread size	d	mm	6,2	7,5	9,9	12,4
Length of anchor PBS-ST	L	mm	-	55 - 240	60 - 240	65 - 240
Length of anchor PBS-I	L	mm	45 - 75	40 - 150	51 - 150	56 - 160
Nominal hole diameter	d ₀	mm	5	6	8	10
Tip chamfer	h _s	mm	2,5	3	4	4,5
Pitch	h _t	mm	4,2	5	6,7	8,3
External thread (PBS-ST)	-	-	-	M8	M10	M12
Internal thread (PBS-I)	-	-	M6	M6, M8, M10, M8/M10	M12	M12, M16
Material: carbon steel	f _{uk}	N/mm ²	1300	1250	1200	1050
	f _{yk}	N/mm ²	1150	1100	1050	950
Coating			Zinc Plated (ZP ≥ 5 μm) or Zinc Flaked (ZF ≥ 5 μm)			



PBS	Annex A2 of European Technical Assessment ETA-19/0551
Product description Dimensions and materials	

Intended use

Anchorage subject to:

- Static and quasi-static loads: all sizes and all embedment depth.
- Anchorages with requirements related to resistance to fire: all sizes and all embedment depths.
- Seismic performance categories C1 and C2: PBS-08, PBS-10 and PBS-14.

Base material:

- Reinforced or unreinforced normal weight concrete with strength class C20/25 to C50/60 according to EN 206.
- Uncracked and cracked concrete: all sizes.

Use conditions (environmental conditions):

- Structures subject to dry internal conditions.

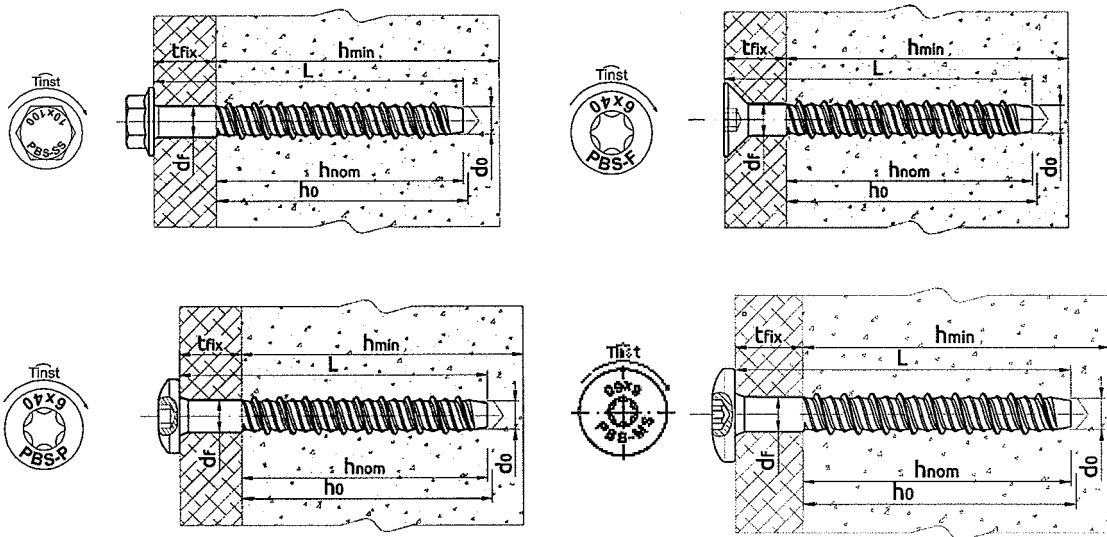
Design:

- Anchorages are designed under the responsibility of an engineer experienced in anchorages and concrete work.
- Verifiable calculation notes and drawings are prepared taking account of the loads to be transmitted. The position of the anchor is indicated on the design drawings (e.g. position of the anchor relative to reinforcement or to supports, etc.).
- Anchorages under static and quasi-static loads, under fire exposure and under seismic actions are designed in accordance with EN 1992-4:2018.

Installation:

- Rotary hammer drilling only: all sizes and all embedment depths.
- Anchor installation carried out by appropriately qualified personnel and under the supervision of the person responsible for technical matters of the site.
- Anchor installation in accordance with the manufacturer's specifications and drawings and using the appropriate tools.
- In case of aborted hole: new drilling at a minimum distance away of twice the depth of the aborted hole or smaller distance if the aborted drill hole is filled with high strength mortar and if under shear or oblique tension load it is not in the direction of load application.
- After installation further turning of the anchor is not possible. The head of the anchor is supported on the fixture and is not damaged.
- Adjustment according to Annex B5 and Table C1.

PBS	Annex B1 of European Technical Assessment ETA-19/0551
Intended use Specification	



Installed anchor PBS-F, PBS-SS, PBS-P and PBS-MS

Table B1: Installation parameters – standard embedment depth

Anchor size			PBS-05	PBS-06	PBS-08	PBS-10	PBS-12	PBS-14
Nominal drill bit diameter	d_{cut}	mm	5	6	8	10	12	14
Maximum drill bit diameter	$d_{cut,max}$	mm	5,40	6,40	8,45	10,45	12,50	14,50
Depth of drill hole*	$h_0 \geq$	mm	50	65	80	95	110	130
Nominal embedment depth	h_{nom}	mm	43	55	70	85	100	120
Effective embedment depth	h_{ef}	mm	32	42	53	65	76	92
Maximum installation torque	$T_{imp,max}$	Nm	200	400	900	950	950	950
Clearance hole in the fixture	$d_f \leq$	mm	7	9	12	14	16	18
Minimum thickness of member	h_{min}	mm	100	100	110	130	155	190
Thickness of the fixture, max.	t_{fix}	mm	$L - h_{nom}$					

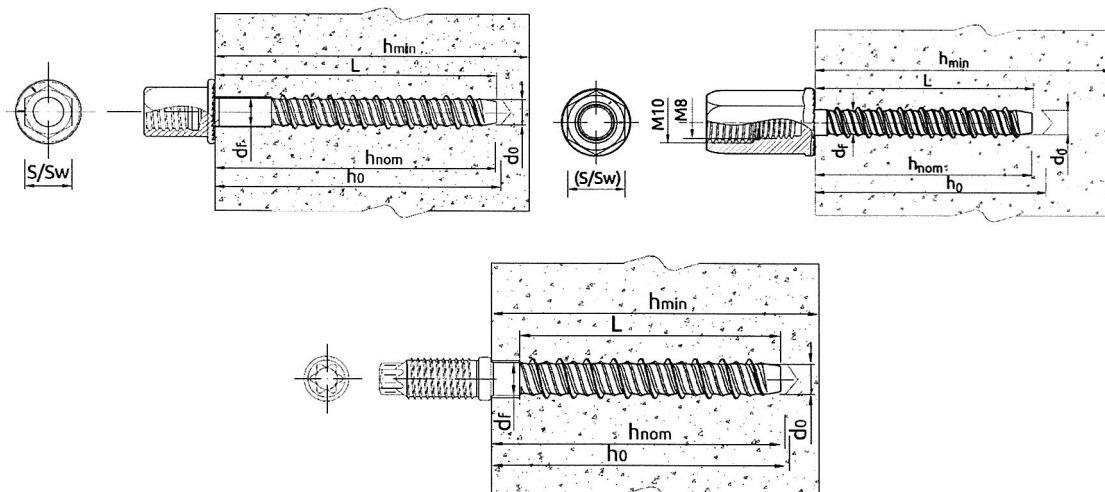
* Real depth of drill hole $h_0 = L + 10 - t_{fix}$

Table B2: Installation parameters – reduced embedment depth

Anchor size			PBS-06	PBS-08	PBS-10	PBS-12	PBS-14
Nominal drill bit diameter	d_{cut}	mm	6	8	10	12	14
Maximum drill bit diameter	$d_{cut,max}$	mm	6,40	8,45	10,45	12,50	14,50
Depth of drill hole	$h_0 \geq$	mm	50	60	65	70	85
Nominal embedment depth	h_{nom}	mm	43	50	55	60	75
Effective embedment depth	h_{ef}	mm	32	36	40	42	54
Maximum installation torque	$T_{imp,max}$	Nm	400	900	950	950	950
Clearance hole in the fixture	$d_f \leq$	mm	9	12	14	16	18
Minimum thickness of member	h_{min}	mm	100	100	100	110	110
Thickness of the fixture, max.	t_{fix}	mm	$L - h_{nom}$				

* Real depth of drill hole $h_0 = L + 10 - t_{fix}$

PBS	Annex B2 of European Technical Assessment ETA-19/0551
Intended use Installation parameters	



Installed anchor PBS-I and PBS-ST

Table B3: Installation parameters – **standard** embedment depth

Anchor size			PBS-05	PBS-06	PBS-08	PBS-10
Nominal drill bit diameter	d_{cut}	mm	5	6	8	10
Maximum drill bit diameter	$d_{cut,max}$	mm	5,40	6,40	8,45	10,45
Depth of drill hole	$h_0 \geq$	mm	50	65	80	95
Nominal embedment depth	h_{nom}	mm	43	55	70	85
Effective embedment depth	h_{ef}	mm	32	42	53	65
Maximum installation torque	$T_{imp,max}$	Nm	200	400	900	950
Minimum thickness of member	h_{min}	mm	100	100	110	130

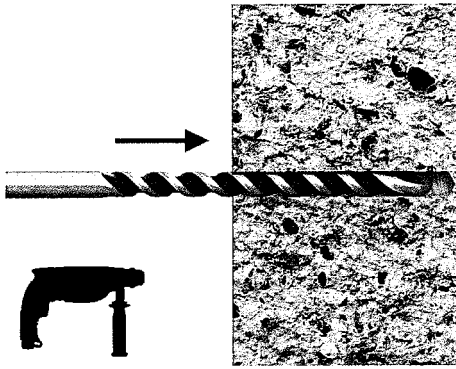
Table B4: Installation parameters – **reduced** embedment depth

Anchor size			PBS-06	PBS-08	PBS-10
Nominal drill bit diameter	d_{cut}	mm	6	8	10
Maximum drill bit diameter	$d_{cut,max}$	mm	6,40	8,45	10,45
Depth of drill hole	$h_0 \geq$	mm	50	60	65
Nominal embedment depth	h_{nom}	mm	39	50	55
Effective embedment depth	h_{ef}	mm	32	36	40
Maximum installation torque	$T_{imp,max}$	Nm	400	900	950
Minimum thickness of member	h_{min}	mm	100	100	100

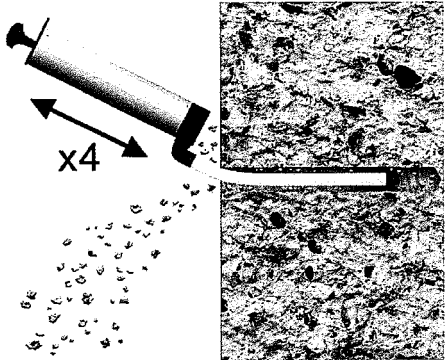
Table B5: Minimum spacing and edge distance

Anchor size			PBS-05	PBS-06	PBS-08	PBS-10	PBS-12	PBS-14
Minimum edge distance	c_{min}	mm	40	45	50	60	80	100
Minimum spacing	s_{min}	mm	40	45	50	60	80	100

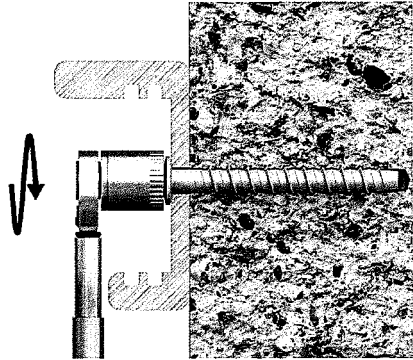
PBS	Annex B3 of European Technical Assessment ETA-19/0551
Intended use Installation parameters	



Drill the hole with rotary hammer drilling machine. Drill to a required depth.

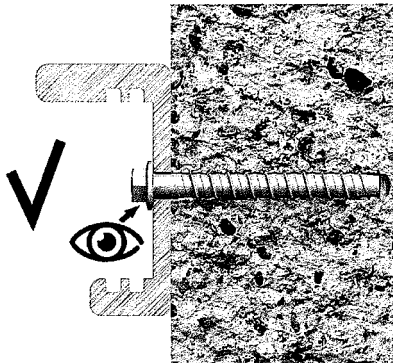


Clean the drill hole (blow out dust at least 4 times with a hand pump).



Tighten the anchor to the substrate.

Installation with any torque impact wrench up to the maximum torque moment ($T_{imp,max}$).



After installation a further turning of the screw must not be possible. The head of the screw must be in contact with the fixture / substrate and be not damaged.

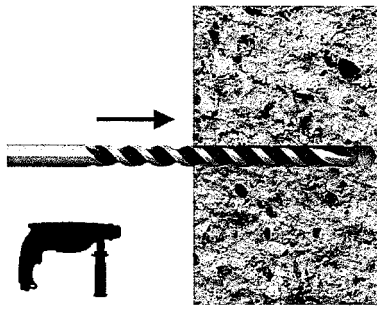
PBS

Intended use

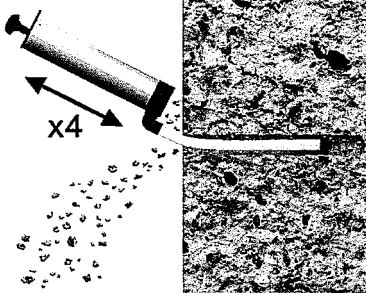
Installation instruction and tools
 PBS-F, PBS-ST, PBS-SS, PBS-I, PBS-P, PBS-MS **without adjustment**

Annex B4

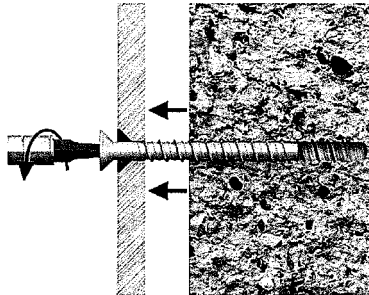
of European
 Technical Assessment
 ETA-19/0551



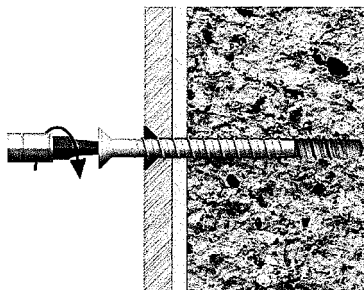
Drill the hole with rotary hammer drilling machine. Drill to a required depth.



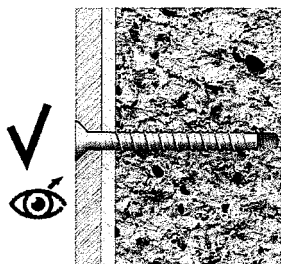
Clean the drill hole (blow out dust at least 4 times with a hand pump).



Possibility of unscrewing and re-screwing.



Tighten the anchor to the substrate.
Installation with any torque impact wrench up to the maximum torque moment ($T_{imp,max}$).



After installation a further turning of the screw must not be possible. The head of the screw must be in contact with the fixture / substrate and be not damaged.

PBS

Annex B5

Intended use
Installation instruction and tools
PBS-F, PBS-ST, PBS-SS, PBS-I, PBS-P, PBS-MS with adjustment

of European
Technical Assessment
ETA-19/0551

Table C1: Characteristic resistance in cracked and uncracked concrete C20/25 to C50/60, design method A

Anchor size			PBS-05	PBS-06		PBS-08		PBS-10		PBS-12		PBS-14		
Nominal embedment depth	h_{nom}	[mm]	43	43	55	50	70	55	85	60	100	75	120	
Adjustment														
Total max. thickness of adjustment layers	t_{adj}	[mm]	10	-	10	-	10	-	10	-	10	-	10	
Max. number of adjustments	n_s	[-]	2	-	2	-	2	-	2	-	2	-	2	
Steel failure														
Characteristic resistance	$N_{Rk,s}$	[kN]	25,5	35,4		60,4		82,4		113,0		157,0		
Partial safety factor	γ_{Ms} ¹⁾	[-]	1,4	1,4		1,4		1,4		1,4		1,5		
Pull-out failure														
Characteristic resistance in uncracked concrete C20/25	$N_{Rk,p}$	[kN]	7,0	-) ²⁾	12,0	-) ²⁾	-) ²⁾	-) ²⁾	-) ²⁾	-) ²⁾	-) ²⁾	-) ²⁾	-) ²⁾	
Characteristic resistance in cracked concrete C20/25	$N_{Rk,p}$	[kN]	4,5	-) ²⁾	7,0	7,0	13,0	8,0	-) ²⁾	7,0	-) ²⁾	13,0	-) ²⁾	
Installation safety factor	γ_{inst}	[-]	1,2	1,0		1,0		1,0		1,0		1,0		
Increasing factor	concrete C30/37	ψ_c	[-]	1,08	1,08	1,08		1,08		1,08		1,08		
	concrete C40/50		[-]	1,15	1,15	1,15		1,15		1,15		1,15		
	concrete C50/60		[-]	1,19	1,19	1,19		1,19		1,19		1,19		
Concrete cone failure and splitting failure														
Effective embedment depth	h_{ef}	[mm]	32	32	42	36	53	40	65	42	76	54	92	
Factor for uncracked concrete	$k_{ucr,N}$	[-]	11,0	11,0		11,0		11,0		11,0		11,0		
Factor for cracked concrete	$k_{cr,N}$	[-]	7,7	7,7		7,7		7,7		7,7		7,7		
Installation safety factor	γ_{inst}	[-]	1,2	1,0		1,0		1,0		1,0		1,0		
Characteristic spacing	concrete cone failure	$s_{cr,N}$	[mm]	90	90	126	112	160	120	196	126	228	165	276
	splitting failure	$s_{cr,sp}$	[mm]	90	90	126	112	160	136	222	126	228	188	312
Characteristic edge distance	concrete cone failure	$c_{cr,N}$	[mm]	45	45	63	56	80	60	98	63	114	83	138
	splitting failure	$c_{cr,sp}$	[mm]	45	45	63	56	80	68	111	63	114	94	156

¹⁾ In the absence of other national regulations

²⁾ Pull-out failure is not decisive

PBS

Performances
Characteristic resistance for tension loads

Annex C1
of European
Technical Assessment
ETA-19/0551

Table C2: Characteristic resistance in cracked and uncracked concrete C20/25 to C50/60, design method A

Anchor size			PBS-05	PBS-06		PBS-08		PBS-10		PBS-12		PBS-14	
Nominal embedment depth	h_{nom}	[mm]	43	43	55	50	70	55	85	60	100	75	120
Steel failure without lever arm													
Characteristic resistance	$V_{Rk,s}$	[kN]	12,7	17,7		30,2		41,2		57,0		78,5	
Factor considering ductility	k_7	[-]	0,8	0,8		0,8		0,8		0,8		0,8	
Partial safety factor	$\gamma_{Ms}^{1)}$	[-]	1,5	1,5		1,5		1,5		1,5		1,5	
Steel failure with lever arm													
Characteristic bending resistance	$M_{Rk,s}^0$	[Nm]	19,0	31,8		72,4		123,6		203,3		329,6	
Partial safety factor	$\gamma_{Ms}^{1)}$	[-]	1,5	1,5		1,5		1,5		1,5		1,5	
Concrete pry-out failure													
Factor	k_8	[-]	1,0	1,0		1,0		1,0	2,0	1,0	2,0	1,0	2,0
Installation safety factor	γ_{inst}	[-]	1,0	1,0		1,0		1,0		1,0		1,0	
Concrete edge failure													
Outside diameter on anchor	d_{nom}	[mm]	5	6		8		10		12		14	
Effective length of anchor under shear loads	l_f	[mm]	43	43	55	50	70	55	85	60	100	75	120
Installation safety factor	γ_{inst}	[-]	1,0	1,0		1,0		1,0		1,0		1,0	
Minimum member thickness	h_{min}	[mm]	100	100	100	100	110	100	130	110	155	110	190
Displacements													
Tension load in uncracked concrete C20/25 to C50/60													
Tension load	N	[kN]	2,9	5,6		11,0		14,9		18,1		23,1	
Short term tension displacement	δ_{N0}	[mm]	0,3	0,3		0,4		0,4		0,5		0,5	
Long term tension displacement	$\delta_{N\infty}$	[mm]	0,85	0,9		1,0		1,0		1,2		1,25	
Tension load in cracked concrete C20/25 to C50/60													
Tension load	N	[kN]	2,3	4,4		6,7		10,2		12,4		17,7	
Short term tension displacement	δ_{N0}	[mm]	0,4	0,4		0,5		0,5		0,6		0,7	
Long term tension displacement	$\delta_{N\infty}$	[mm]	2,0	2,0		2,0		2,0		2,0		2,0	
Shear load in cracked and uncracked concrete C20/25 to C50/60													
Shear load	V	[kN]	5,6	8,1		11,9		18,7		27,1		35,2	
Short term shear displacement	δ_{V0}	[mm]	1,4	1,5		2,5		2,5		2,5		2,5	
Long term shear displacement	$\delta_{V\infty}$	[mm]	2,1	2,25		3,75		3,75		3,75		3,75	

¹⁾ In the absence of other national regulations

PBS

Performances
Characteristic resistance for shear loads. Displacements

Annex C2
of European
Technical Assessment
ETA-19/0551

Table C3: Characteristic values for seismic performance category C1

Anchor size			PBS-08	PBS-10	PBS-14
Nominal embedment depth	h_{nom}	[mm]	70	85	120
Steel failure for tension and shear load					
Characteristic resistance	$N_{Rk,s,eq}$	[kN]	60,4	82,4	157,0
	$V_{Rk,s,eq}$	[kN]	15,1	27,4	52,3
Pullout failure					
Characteristic resistance	$N_{Rk,p,eq}$	[kN]	5,4	13,5	19,2
Concrete cone failure					
Effective embedment depth	h_{ef}	[mm]	53	65	92
Characteristic edge distance	$c_{cr,N}$	[mm]	$1,5 \cdot h_{ef}$		
Characteristic spacing	$s_{cr,N}$	[mm]	$3 \cdot h_{ef}$		
Installation safety factor	γ_{inst}	[-]	1,0		
Concrete pry-out failure					
Factor	k_B	[-]	1,0	2,0	2,0
Concrete edge failure					
Outside diameter on anchor	d_{nom}	[mm]	8	10	14
Effective length of anchor under shear loads	l_f	[mm]	70	85	120

PBS

Performances
Characteristic values for seismic performance category C1

Annex C3
of European
Technical Assessment
ETA-19/0551

Table C4: Characteristic values for seismic performance category C2

Anchor size			PBS-08	PBS-10	PBS-14
Nominal embedment depth	h_{nom}	[mm]	70	85	120
Steel failure for tension and shear load					
Characteristic resistance	$N_{Rk,s,eq}$	[kN]	60,4	82,4	157,0
	$V_{Rk,s,eq}$	[kN]	9,9	20,6	35,1
Pullout failure					
Characteristic resistance	$N_{Rk,p,eq}$	[kN]	1,57	4,91	14,87
Concrete cone failure					
Effective embedment depth	h_{ef}	[mm]	53	65	92
Characteristic edge distance	$c_{cr,N}$	[mm]	$1,5 \cdot h_{ef}$		
Characteristic spacing	$s_{cr,N}$	[mm]	$3 \cdot h_{ef}$		
Installation factor	γ_{inst}	[-]	1,0		
Concrete pry-out failure					
Factor	k_8	[-]	1,0	2,0	2,0
Concrete edge failure					
Outside diameter on anchor	d_{nom}	[mm]	8	10	14
Effective length of anchor under shear loads	l_f	[mm]	70	85	120
Displacements					
Displacements under tension load					
Displacement DLS	$\delta_{N,eq}$	[mm]	0,10	0,20	0,63
Displacement ULS	$\delta_{N,eq}$	[mm]	0,50	0,73	3,94
Displacements under shear load					
Displacement DLS	$\delta_{V,eq}$	[mm]	2,00	3,44	4,22
Displacement ULS	$\delta_{V,eq}$	[mm]	3,04	5,04	7,15

PBS

Performances
Characteristic values for seismic performance category C2

Annex C4
of European
Technical Assessment
ETA-19/0551

Table C5: Characteristic resistance under fire exposure in cracked and uncracked concrete C20/25 to C50/60

Anchor size			PBS-05	PBS-06		PBS-08		PBS-10		PBS-12		PBS-14		
Nominal embedment depth	h_{nom}	[mm]	43	43	55	50	70	55	85	60	100	75	120	
Steel failure for tension and shear load $F_{Rk,s,fi} = N_{Rk,s,fi} = V_{Rk,s,fi}$														
Characteristic resistance	R30	$F_{Rk,s,fi}$	[kN]	0,20	0,28	0,28	0,75	0,75	1,57	1,57	2,26	2,26	3,08	3,08
	R60	$F_{Rk,s,fi}$	[kN]	0,18	0,25	0,25	0,65	0,65	1,18	1,18	1,70	1,70	2,31	2,31
	R90	$F_{Rk,s,fi}$	[kN]	0,14	0,20	0,20	0,50	0,50	1,02	1,02	1,47	1,47	2,00	2,00
	R120	$F_{Rk,s,fi}$	[kN]	0,10	0,14	0,14	0,40	0,40	0,79	0,79	1,13	1,13	1,54	1,54
	R30	$M^0_{Rk,s,fi}$	[Nm]	0,15	0,25	0,25	0,90	0,90	2,36	2,36	4,07	4,07	6,47	6,47
	R60	$M^0_{Rk,s,fi}$	[Nm]	0,13	0,23	0,23	0,78	0,78	1,77	1,77	3,05	3,05	4,85	4,85
	R90	$M^0_{Rk,s,fi}$	[Nm]	0,10	0,18	0,18	0,60	0,60	1,53	1,53	2,65	2,65	4,20	4,20
	R120	$M^0_{Rk,s,fi}$	[Nm]	0,07	0,13	0,13	0,48	0,48	1,18	1,18	2,04	2,04	3,23	3,23
Pull-out failure														
Characteristic resistance	R30	$N_{Rk,p,fi}$	[kN]	1,13	1,38	1,75	1,88	3,25	2,00	4,75	1,75	6,50	3,25	8,50
	R60	$N_{Rk,p,fi}$	[kN]	1,13	1,38	1,75	1,88	3,25	2,00	4,75	1,75	6,50	3,25	8,50
	R90	$N_{Rk,p,fi}$	[kN]	1,13	1,38	1,75	1,88	3,25	2,00	4,75	1,75	6,50	3,25	8,50
	R120	$N_{Rk,p,fi}$	[kN]	0,90	1,10	1,40	1,50	2,60	1,60	3,80	1,40	5,20	2,60	6,80
Concrete cone failure														
Characteristic resistance	R30	$N_{Rk,c,fi}$	[kN]	0,89	0,89	2,06	1,50	3,68	1,82	6,13	2,06	9,06	4,04	14,61
	R60	$N_{Rk,c,fi}$	[kN]	0,89	0,89	2,06	1,50	3,68	1,82	6,13	2,06	9,06	4,04	14,61
	R90	$N_{Rk,c,fi}$	[kN]	0,89	0,89	2,06	1,50	3,68	1,82	6,13	2,06	9,06	4,04	14,61
	R120	$N_{Rk,c,fi}$	[kN]	0,71	0,71	1,65	1,20	2,94	1,46	4,91	1,65	7,25	3,23	11,69
Edge distance														
R30 to R120	$c_{cr,fi}$	[mm]	2· h_{ef}											
In case of fire attack from more than one side, the minimum edge distance shall be ≥ 300 mm.														
Anchor spacing														
R30 to R120	$s_{cr,fi}$	[mm]	4· h_{ef}											
Concrete pry-out failure														
R30 to R120	k	[-]	1,0	1,0	1,0	1,0	1,0	1,0	1,0	2,0	1,0	2,0	1,0	2,0

PBS

Performances
Characteristic resistance under fire exposure

Annex C5
of European
Technical Assessment
ETA-19/0551